



Round	Wrestler red	- Wrestler blue	Points		Time	Technical points	
			W : W	TP : TP		Points	Technical poi
Senior 60 kg							
Qual.	Helary Mägisalu (ESTONIA)	- Myroslav Solovian (UKRAINE)	1,0 : 3,0	5 : 7	06:00 PS	1;22	P12;220
Qual.	Colton Rasche (USA)	- Andy Juan (SPAIN)	5,0 : 0,0	6 : 3	03:40 SS	4;2	21;
Qual.	Mattias Poutanen (FINLAND)	- Jacob Tangen (NORWAY)	3,0 : 1,0	5 : 1	06:00 PS	P;212	1;P
Qual.	Maksym Liu (UKRAINE)	- Juuso Latvala (Ilmajoen Kisailijat (FIN))	1,0 : 3,0	2 : 4	06:00 PS	P;2	12;1
1/4 Fin.	Daniel Bobillo (SPAIN)	- Arttu Hakala (Vaasan Voima-Veikot (FIN))	3,0 : 1,0	7 : 3	06:00 PS	12;4	P2;1
1/4 Fin.	Albert Baghumyan (SPAIN)	- Lauri Karjalainen (Perhon Kiri (FIN))	4,0 : 0,0	8 : 0	01:10 TÛ	224;	
1/4 Fin.	Myroslav Solovian (UKRAINE)	- Colton Rasche (USA)	4,0 : 1,0	11 : 2	02:01 TÛ	14222;	2;
1/4 Fin.	Mattias Poutanen (FINLAND)	- Juuso Latvala (Ilmajoen Kisailijat (FIN))	1,0 : 3,0	1 : 4	06:00 PS	1;	P;4
1/2 Fin.	Daniel Bobillo (SPAIN)	- Albert Baghumyan (SPAIN)	0,0 : 4,0	0 : 8	02:54 TÛ	P;	1241;
1/2 Fin.	Myroslav Solovian (UKRAINE)	- Juuso Latvala (Ilmajoen Kisailijat (FIN))	0,0 : 4,0	0 : 9	01:46 TÛ	P;	12222;
Hoffnungsrund	Maksym Liu (UKRAINE)	- Mattias Poutanen (FINLAND)	4,0 : 0,0	9 : 0	01:37 TÛ	12222;	P;
Platz 3+5	Lauri Karjalainen (Perhon Kiri (FIN))	- Daniel Bobillo (SPAIN)	1,0 : 3,0	2 : 7	06:00 PS	1;P1	P;124
Platz 3+5	Maksym Liu (UKRAINE)	- Myroslav Solovian (UKRAINE)	1,0 : 3,0	3 : 3	06:00 PS	12;P	P;12
Finale	Albert Baghumyan (SPAIN)	- Juuso Latvala (Ilmajoen Kisailijat (FIN))	3,0 : 1,0	4 : 2	06:00 PS	2;11	;P2
Senior 67 kg							
1/8 Finale	Vilho Laukkarinen (Vaajakosken Kuuhu)	- Ott Saar (ESTONIA)	0,0 : 4,0	0 : 8	01:44 TÛ	P;	11222;
1/8 Finale	Serhii Hrushyn (UKRAINE)	- Erik Leikkari (Seinäjoen Paini-Miehet (FIN))	4,0 : 0,0	9 : 0	01:41 TÛ	12222;	P;
1/8 Finale	Aleksi Seppälä (Ilmajoen Kisailijat (FIN))	- Jamel Johnson (USA)	0,0 : 4,0	0 : 8	01:16 TÛ		422;
1/8 Finale	Marcos Sanchez (SPAIN)	- Alejandro Concepcion (SPAIN)	1,0 : 3,0	1 : 6	06:00 PS	P;P1	221;1
1/8 Finale	Jussi Autio (Seinäjoen Paini-Miehet (FIN))	- Marat Garipov (St. Petersburg (RUS))	0,0 : 3,0	0 : 7	06:00 PS	;P	222;1
1/8 Finale	Joni Komppa (FINLAND)	- Denis Bolunov (ESTONIA)	4,0 : 0,0	8 : 0	05:22 TÛ	15;2	P;



Round	Wrestler red	- Wrestler blue	Points		Time	Technical points	
			W : W	TP : TP		Points	Technical poi
1/8 Finale	Alexander Bica (SWEDEN)	- Pål Eirik Gundersen (NORWAY)	0,0 : 3,0	0 : 7	06:00 PS	P;	1222;
1/8 Finale	Raffaele Masi (USA)	- Marcus Sellden (SWEDEN)	0,0 : 4,0	0 : 8	00:28 TÛ		242;
1/4 Fin.	Ott Saar (ESTONIA)	- Serhii Hrushyn (UKRAINE)	0,0 : 4,0	0 : 8	01:40 TÛ	P;	125;
1/4 Fin.	Jamel Johnson (USA)	- Alejandro Concepcion (SPAIN)	4,0 : 0,0	9 : 0	05:20 TÛ	12;222	P;
1/4 Fin.	Marat Garipov (St. Petersburg (RUS))	- Joni Komppa (FINLAND)	5,0 : 0,0	9 : 0	03:55 SS	12;24	P;
1/4 Fin.	Pål Eirik Gundersen (NORWAY)	- Marcus Sellden (SWEDEN)	3,0 : 1,0	7 : 1	06:00 PS	P;214	1;P
1/2 Fin.	Serhii Hrushyn (UKRAINE)	- Jamel Johnson (USA)	5,0 : 0,0	8 : 0	01:57 SS	44;	
1/2 Fin.	Marat Garipov (St. Petersburg (RUS))	- Pål Eirik Gundersen (NORWAY)	3,0 : 1,0	5 : 3	06:00 PS	P212;	12;
Hoffnungsrun	Erik Leikkari (Seinäjoen Paini-Miehet (FIN))	- Ott Saar (ESTONIA)	1,0 : 4,0	2 : 11	04:35 TÛ	2;0	21;2222
Hoffnungsrun	Jussi Autio (Seinäjoen Paini-Miehet (FIN))	- Joni Komppa (FINLAND)	0,0 : 4,0	0 : 12	01:43 TÛ	P;	1425;
Platz 3+5	Ott Saar (ESTONIA)	- Jamel Johnson (USA)	5,0 : 0,0	4 : 1	02:36 AS	22;	1;
Platz 3+5	Joni Komppa (FINLAND)	- Pål Eirik Gundersen (NORWAY)	1,0 : 3,0	1 : 3	06:00 PS	P;1	1;P2
Finale	Serhii Hrushyn (UKRAINE)	- Marat Garipov (St. Petersburg (RUS))	1,0 : 4,0	2 : 10	02:40 TÛ	2;	424;
Senior 72 kg							
Qual.	Ihor Bychkov (UKRAINE)	- Leevi Ukkola (Haukiputaan Heitto (FIN))	4,0 : 0,0	8 : 0	01:30 TÛ	422;	
Qual.	Vladyslav Kravchenko (UKRAINE)	- Sebastian Aak (NORWAY)	1,0 : 4,0	2 : 11	02:09 TÛ	2;	42221;
1/4 Fin.	Daniel Soini (SWEDEN)	- Simon Erlandsson (SWEDEN)	0,0 : 3,0	0 : 2	06:00 PS	P;P	1;1
1/4 Fin.	Akseli Yli-Hannuksela (FINLAND)	- Raymond Bunker (USA)	3,0 : 1,0	7 : 5	06:00 PS	15;1P	P;212
1/4 Fin.	Jegor Jakolev (ESTONIA)	- Salim Al Rays (SWEDEN)	3,0 : 1,0	4 : 4	06:00 PS	P;P121	1;12
1/4 Fin.	Ihor Bychkov (UKRAINE)	- Sebastian Aak (NORWAY)	5,0 : 0,0	4 : 6	02:54 SS	22;	24;
1/2 Fin.	Simon Erlandsson (SWEDEN)	- Akseli Yli-Hannuksela (FINLAND)	1,0 : 4,0	1 : 10	04:54 TÛ	1;P	P;1522
1/2 Fin.	Jegor Jakolev (ESTONIA)	- Ihor Bychkov (UKRAINE)	0,0 : 4,0	0 : 8	04:06 TÛ	P;P	122;12
Hoffnungsrun	Leevi Ukkola (Haukiputaan Heitto (FIN))	- Sebastian Aak (NORWAY)	1,0 : 4,0	2 : 13	02:59 TÛ	2PP;	21424;



Round	Wrestler red	- Wrestler blue	Points		Time	Technical points	
			W : W	TP : TP		Points	Technical poi
Platz 3+5	Raymond Bunker (USA)	- Simon Erlandsson (SWEDEN)	1,0 : 3,0	1 : 3	06:00 PS	P;P1	1;11
Platz 3+5	Sebastian Aak (NORWAY)	- Jegor Jakolev (ESTONIA)	4,0 : 0,0	8 : 0	01:09 TÛ	224;	
Finale	Akseli Yli-Hannuksela (FINLAND)	- Ihor Bychkov (UKRAINE)	3,0 : 1,0	5 : 1	06:00 PS	P;122	1;P
Senior 77 kg							
Qual.	Spenser Woods (USA)	- Per Anders Kure (NORWAY)	0,0 : 4,0	0 : 8	00:50 TÛ		422;
Qual.	Andre Isberg (SWEDEN)	- Matias Lipasti (FINLAND)	0,0 : 3,0	0 : 5	06:00 PS	;P	22;1
Qual.	Petteri Kukkola (Haukiputaan Heitto (FIN))	- Sakke Purolainen (Koovee (FIN))	0,0 : 4,0	0 : 9	02:06 TÛ		41211;
Qual.	Roni Purolainen (Koovee (FIN))	- Juri Denisov (St. Petersburg (RUS))	1,0 : 3,0	1 : 7	06:00 PS	1;	P;142
Qual.	Chingiz Labazanov (St. Petersburg (RU))	- Lukas Ahlgren (SWEDEN)	3,0 : 1,0	5 : 1	06:00 PS	P;122	1;P
Qual.	Iiro Piippo (Vaajakosken Kuohu (FIN))	- Payton Walsh (USA)	0,0 : 5,0	2 : 12	02:45 SS	20;	222222;
Qual.	Mike Donato (USA)	- Niko Erkkola (Ilmajoen Kisailijat (FIN))	0,0 : 4,0	0 : 8	00:31 TÛ		44;
1/4 Fin.	Pat Smith (USA)	- Per Anders Kure (NORWAY)	3,0 : 0,0	3 : 0	06:00 PS	11;1	P;
1/4 Fin.	Matias Lipasti (FINLAND)	- Sakke Purolainen (Koovee (FIN))	3,0 : 1,0	2 : 1	06:00 PS	P;11	1;PP
1/4 Fin.	Juri Denisov (St. Petersburg (RUS))	- Chingiz Labazanov (St. Petersburg (RU))	1,0 : 3,0	1 : 1	06:00 PS	1;P	P;1
1/4 Fin.	Payton Walsh (USA)	- Niko Erkkola (Ilmajoen Kisailijat (FIN))	1,0 : 3,0	3 : 8	06:00 PS	12;	2;222
1/2 Fin.	Pat Smith (USA)	- Matias Lipasti (FINLAND)	5,0 : 0,0	7 : 2	06:00 SS	1;222	P;2
1/2 Fin.	Chingiz Labazanov (St. Petersburg (RU))	- Niko Erkkola (Ilmajoen Kisailijat (FIN))	4,0 : 0,0	8 : 0	01:33 TÛ	422;	
Hoffnungsrun	Lukas Ahlgren (SWEDEN)	- Juri Denisov (St. Petersburg (RUS))	1,0 : 3,0	1 : 5	06:00 PS	1;	P;212
Platz 3+5	Per Anders Kure (NORWAY)	- Matias Lipasti (FINLAND)	5,0 : 0,0	0 : 0	00:00 KL		
Platz 3+5	Juri Denisov (St. Petersburg (RUS))	- Niko Erkkola (Ilmajoen Kisailijat (FIN))	0,0 : 5,0	0 : 0	00:00 KL		
Finale	Pat Smith (USA)	- Chingiz Labazanov (St. Petersburg (RU))	1,0 : 3,0	1 : 3	06:00 PS	P;1	12;P



Round	Wrestler red	- Wrestler blue	Points		Time	Technical points		
			W : W	TP : TP		Points	Technical poi	Technical poi
Senior 82 kg								
1/8 Finale	Vili Ropponen (FINLAND)	- Andreas Välis (ESTONIA)	3,0 : 1,0	5 : 1	06:00 PS	1112;P	P;1	
1/8 Finale	Oskari Lehtonen (Helsingin Haka (FIN))	- Einari Ukkola (Haukiputaan Heitto (FIN))	3,0 : 1,0	8 : 3	06:00 PS	P;1142	12;P	
1/8 Finale	Dmytro Gardubei (UKRAINE)	- Milad Gardniya (Kajaanin Juntta (FIN))	5,0 : 0,0	4 : 0	01:36 SS	4;		
1/8 Finale	Oskar Johansson (SWEDEN)	- Terrence Zaleski (USA)	3,0 : 1,0	1 : 1	06:00 PS	P;1	1;P	
1/8 Finale	Otto Ketonen (Ilmajoen Kisailijat (FIN))	- Hans Uku Leitham (ESTONIA)	5,0 : 0,0	0 : 0	00:00 AS			
1/8 Finale	Raoul Aho Leitham (ESTONIA)	- Exauce Mukubu (NORWAY)	0,0 : 4,0	0 : 8	03:33 TÛ	P;	112;4	
1/8 Finale	Markus Sihtola (Ylä-Tikkurilan Kipinä (FIN))	- Jarno Ålander (Helsingin Tarmo (FIN))	1,0 : 3,0	1 : 4	06:00 PS	P;1	1;12	
1/8 Finale	Vitalii Andriiovych (UKRAINE)	- John Stefanowicz (USA)	3,0 : 1,0	12 : 8	06:00 PS	124;221	P4;4	
1/4 Fin.	Vili Ropponen (FINLAND)	- Oskari Lehtonen (Helsingin Haka (FIN))	3,0 : 0,0	5 : 0	06:00 PS	12;2	P;	
1/4 Fin.	Dmytro Gardubei (UKRAINE)	- Oskar Johansson (SWEDEN)	3,0 : 0,0	5 : 0	06:00 PS	122;	P;	
1/4 Fin.	Otto Ketonen (Ilmajoen Kisailijat (FIN))	- Exauce Mukubu (NORWAY)	3,0 : 0,0	4 : 0	06:00 PS	12;1	P;	
1/4 Fin.	Jarno Ålander (Helsingin Tarmo (FIN))	- Vitalii Andriiovych (UKRAINE)	0,0 : 3,0	0 : 3	06:00 PS	P;P	1;11	
1/2 Fin.	Vili Ropponen (FINLAND)	- Dmytro Gardubei (UKRAINE)	3,0 : 1,0	5 : 1	06:00 PS	1211;P	P;1	
1/2 Fin.	Otto Ketonen (Ilmajoen Kisailijat (FIN))	- Vitalii Andriiovych (UKRAINE)	5,0 : 0,0	6 : 0	02:00 DS	1212;	P00;	
Hoffnungsrun	Andreas Välis (ESTONIA)	- Oskari Lehtonen (Helsingin Haka (FIN))	3,0 : 1,0	2 : 1	06:00 PS	2;P	;1	
Hoffnungsrun	Hans Uku Leitham (ESTONIA)	- Exauce Mukubu (NORWAY)	0,0 : 5,0	0 : 0	00:00 KL			
Platz 3+5	Andreas Välis (ESTONIA)	- Dmytro Gardubei (UKRAINE)	0,0 : 3,0	0 : 2	06:00 PS	P;P	1;1	
Platz 3+5	Exauce Mukubu (NORWAY)	- Vitalii Andriiovych (UKRAINE)	0,0 : 5,0	6 : 11	05:37 SS	2;4	12;224	
Finale	Vili Ropponen (FINLAND)	- Otto Ketonen (Ilmajoen Kisailijat (FIN))	3,0 : 0,0	4 : 0	06:00 PS	1;12	P;P	



Round	Wrestler red	- Wrestler blue	Points		Time	Technical points	
			W : W	TP : TP		Points	Technical poi
Senior 87 kg							
Qual.	Erik Int (ESTONIA)	- Sergio Iglesias (SPAIN)	4,0 : 0,0	9 : 0	01:02 TÜ	12222;	P;
Qual.	Valentyn Shkliarenko (UKRAINE)	- Alexander Stjepanetic (SWEDEN)	1,0 : 3,0	4 : 10	06:00 PS	P22;P	124;12
Qual.	Jesus Gasca (SPAIN)	- Keaton Fanning (USA)	3,0 : 1,0	7 : 1	06:00 PS	11;122	1P;P
Qual.	Arttu-Petteri Klami (Kotkan Painimiehet (F-	- Pedro J Garcia (SPAIN)	0,0 : 5,0	0 : 4	00:31 SS		4;
1/4 Fin.	Josef Rau (USA)	- Arkadiusz Kulynych (POLAND)	0,0 : 5,0	7 : 6	04:25 SS	2221;	2;4
1/4 Fin.	Tommy Brackett (USA)	- Toni Metsomäki (FINLAND)	0,0 : 5,0	0 : 0	00:51 KL		
1/4 Fin.	Erik Int (ESTONIA)	- Alexander Stjepanetic (SWEDEN)	0,0 : 4,0	0 : 8	05:30 TÜ	P;P	1;142
1/4 Fin.	Jesus Gasca (SPAIN)	- Pedro J Garcia (SPAIN)	0,0 : 4,0	0 : 8	01:34 TÜ	0;	512;
1/2 Fin.	Arkadiusz Kulynych (POLAND)	- Toni Metsomäki (FINLAND)	1,0 : 4,0	1 : 10	02:16 TÜ	1;	2422;
1/2 Fin.	Alexander Stjepanetic (SWEDEN)	- Pedro J Garcia (SPAIN)	0,0 : 4,0	0 : 9	01:56 TÜ	P;	12222;
Hoffnungsrund	Arttu-Petteri Klami (Kotkan Painimiehet (F-	- Jesus Gasca (SPAIN)	0,0 : 4,0	0 : 9	01:58 TÜ	P;	12222;
Platz 3+5	Tommy Brackett (USA)	- Arkadiusz Kulynych (POLAND)	0,0 : 4,0	0 : 9	04:29 TÜ	P;	122;22
Platz 3+5	Jesus Gasca (SPAIN)	- Alexander Stjepanetic (SWEDEN)	0,0 : 4,0	0 : 9	02:29 TÜ		2421;
Finale	Toni Metsomäki (FINLAND)	- Pedro J Garcia (SPAIN)	4,0 : 1,0	13 : 3	04:31 TÜ	12;211222	P1;2
Senior 97 kg							
Qual.	Abin Frid (SWEDEN)	- Daniel Miller (USA)	0,0 : 4,0	0 : 9	01:56 TÜ	P;	12222;
1/4 Fin.	Billy Rääf (SWEDEN)	- Eric Twohey (USA)	0,0 : 3,0	0 : 4	06:00 PS	P;P	1;12
1/4 Fin.	Ben Durbin (USA)	- Kevin Bauman (ESTONIA)	0,0 : 5,0	0 : 6	01:33 SS		42;
1/4 Fin.	Arvi Savolainen (FINLAND)	- Oleksandr Yevdokimov (UKRAINE)	4,0 : 0,0	9 : 0	02:23 TÜ	21222;	P;
1/4 Fin.	Elias Kuosmanen (Helsingin Haka (FIN)-	- Daniel Miller (USA)	3,0 : 1,0	7 : 4	06:00 PS	124;	P;4
1/2 Fin.	Eric Twohey (USA)	- Kevin Bauman (ESTONIA)	3,0 : 1,0	2 : 1	06:00 PS	1;1	P;1
1/2 Fin.	Arvi Savolainen (FINLAND)	- Elias Kuosmanen (Helsingin Haka (FIN))	3,0 : 1,0	3 : 1	06:00 PS	2;1P	;P1



Round	Wrestler red	- Wrestler blue	Points		Time	Technical points	
			W : W	TP : TP		Points	Technical poi
Platz 3+5	Billy Rääf (SWEDEN)	- Kevin Bauman (ESTONIA)	3,0 : 1,0	7 : 5	06:00 PS	1222;P	P;212
Platz 3+5	Oleksandr Yevdokimov (UKRAINE)	- Elias Kuosmanen (Helsingin Haka (FIN))	0,0 : 3,0	0 : 7	06:00 PS	P;	1222;
Finale	Eric Twohey (USA)	- Arvi Savolainen (FINLAND)	0,0 : 4,0	0 : 9	03:30 TÜ	P;	1222;2
Senior 130 kg							
1/4 Fin.	Georgi Helaya (St. Petersburg (RUS))	- Nicolas Lopez Gredilla (SPAIN)	4,0 : 0,0	10 : 0	02:49 TÜ	2224;	
1/4 Fin.	Konsta Mäenpää (FINLAND)	- Artur Vititin (ESTONIA)	5,0 : 0,0	6 : 3	03:58 SS	P4;2	12;
1/4 Fin.	Kaarel Maaten (ESTONIA)	- Tuomas Lahti (Ylä-Tikkurilan Kipinä (FI))	0,0 : 4,0	0 : 8	00:54 TÜ		2222;
1/4 Fin.	Nikola Milatovic (NORWAY)	- Trent Osnes (USA)	1,0 : 3,0	5 : 6	06:00 PS	2;12	222;P
1/2 Fin.	Georgi Helaya (St. Petersburg (RUS))	- Konsta Mäenpää (FINLAND)	0,0 : 3,0	0 : 7	06:00 PS	P;	1;24
1/2 Fin.	Tuomas Lahti (Ylä-Tikkurilan Kipinä (FI))	- Trent Osnes (USA)	4,0 : 0,0	9 : 0	01:46 TÜ	22122;	P;
Platz 3+5	Artur Vititin (ESTONIA)	- Georgi Helaya (St. Petersburg (RUS))	3,0 : 1,0	3 : 3	06:00 PS	P;12	12;P
Platz 3+5	Kaarel Maaten (ESTONIA)	- Trent Osnes (USA)	3,0 : 1,0	4 : 1	06:00 PS	21;1	P;1
Finale	Konsta Mäenpää (FINLAND)	- Tuomas Lahti (Ylä-Tikkurilan Kipinä (FI))	1,0 : 3,0	5 : 7	06:00 PS	P;122	1222;P00



Senior

98 Participants

60 kg Senior

1.	Albert Baghumyan	SPAIN
2.	Juuso Latvala	Ilmajoen Kisailijat (FIN)
3.	Myroslav Solovian	UKRAINE
3.	Daniel Bobillo	SPAIN
5.	Maksym Liu	UKRAINE
5.	Lauri Karjalainen	Perhon Kiri (FIN)
7.	Colton Rasche	USA
8.	Mattias Poutanen	FINLAND
9.	Helary Mägisalu	ESTONIA
10.	Arttu Hakala	Vaasan Voima-Veikot (FIN)
11.	Jacob Tangen	NORWAY
12.	Andy Juan	SPAIN

67 kg Senior

1.	Marat Garipov	St. Petersburg (RUS)
2.	Serhii Hrushyn	UKRAINE
3.	Pål Eirik Gundersen	NORWAY
3.	Ott Saar	ESTONIA
5.	Jamel Johnson	USA
5.	Joni Komppa	FINLAND
7.	Marcus Sellden	SWEDEN
8.	Alejandro Concepcion	SPAIN
9.	Erik Leikkari	Seinäjoen Paini-Miehet (FIN)
10.	Marcos Sanchez	SPAIN
11.	Alexander Bica	SWEDEN
12.	Denis Bolunov	ESTONIA
12.	Vilho Laukkarinen	Vaajakosken Kuohu (FIN)
12.	Aleksi Seppälä	Ilmajoen Kisailijat (FIN)
12.	Raffaele Masi	USA
16.	Jussi Autio	Seinäjoen Paini-Miehet (FIN)

72 kg Senior

1.	Akseli Yli-Hannuksela	FINLAND
2.	Ihor Bychkov	UKRAINE
3.	Simon Erlandsson	SWEDEN
3.	Sebastian Aak	NORWAY
5.	Raymond Bunker	USA
5.	Jegor Jakolev	ESTONIA
7.	Salim Al Rays	SWEDEN
8.	Vladyslav Kravchenko	UKRAINE
9.	Leevi Ukkola	Haukiputaan Heitto (FIN)
10.	Daniel Soini	SWEDEN

77 kg Senior

1.	Chingiz Labazanov	St. Petersburg (RUS)
2.	Pat Smith	USA
3.	Niko Erkkola	Ilmajoen Kisailijat (FIN)
3.	Per Anders Kure	NORWAY
5.	Matias Lipasti	FINLAND
5.	Juri Denisov	St. Petersburg (RUS)
7.	Payton Walsh	USA
8.	Sakke Purolainen	Koovee (FIN)
9.	Lukas Ahlgren	SWEDEN
10.	Roni Purolainen	Koovee (FIN)
11.	Iiro Piippo	Vaajakosken Kuohu (FIN)
12.	Andre Isberg	SWEDEN
13.	Mike Donato	USA
13.	Spenser Woods	USA
15.	Petteri Kukkola	Haukiputaan Heitto (FIN)

**82 kg Senior**

1.	Vili Ropponen	FINLAND
2.	Otto Ketonen	Ilmajoen Kisailijat (FIN)
3.	Vitalii Andriiovych	UKRAINE
3.	Dmytro Gardubei	UKRAINE
5.	Exauce Mukubu	NORWAY
5.	Andreas Välis	ESTONIA
7.	Oskari Lehtonen	Helsingin Haka (FIN)
8.	Jarno Ålander	Helsingin Tarmo (FIN)
9.	Oskar Johansson	SWEDEN
10.	John Stefanowicz	USA
11.	Einari Ukkola	Haukiputaan Heitto (FIN)
12.	Terrence Zaleski	USA
13.	Markus Sihtola	Ylä-Tikkurilan Kipinä (FIN)
14.	Hans Uku Leitham	ESTONIA
15.	Milad Gardniya	Kajaanin Juntta (FIN)
16.	Raoul Aho Leitham	ESTONIA

87 kg Senior

1.	Toni Metsomäki	FINLAND
2.	Pedro J Garcia	SPAIN
3.	Arkadiusz Kulynycz	POLAND
3.	Alexander Stjepanetic	SWEDEN
5.	Jesus Gasca	SPAIN
5.	Tommy Brackett	USA
7.	Erik Int	ESTONIA
8.	Valentyn Shkliarenko	UKRAINE
9.	Keaton Fanning	USA
10.	Josef Rau	USA
11.	Sergio Iglesias	SPAIN
12.	Arttu-Petteri Klami	Kotkan Painimiehet (FIN)

97 kg Senior

1.	Arvi Savolainen	FINLAND
2.	Eric Twohey	USA
3.	Billy Rääf	SWEDEN
3.	Elias Kuosmanen	Helsingin Haka (FIN)
5.	Kevin Bauman	ESTONIA
5.	Oleksandr Yevdokimov	UKRAINE
7.	Daniel Miller	USA
8.	Ben Durbin	USA
9.	Abin Frid	SWEDEN

130 kg Senior

1.	Tuomas Lahti	Ylä-Tikkurilan Kipinä (FIN)
2.	Konsta Mäenpää	FINLAND
3.	Artur Vititin	ESTONIA
3.	Kaarel Maaten	ESTONIA
5.	Georgi Helaya	St. Petersburg (RUS)
5.	Trent Osnes	USA
7.	Nikola Milatovic	NORWAY
8.	Nicolas Lopez Gredilla	SPAIN



Competition Sheet

Ilmajoki, 8.12.2018

12 Participants

International Arvo Haavisto Tournament (UWW)

Senior

Category

60kg

Weight class

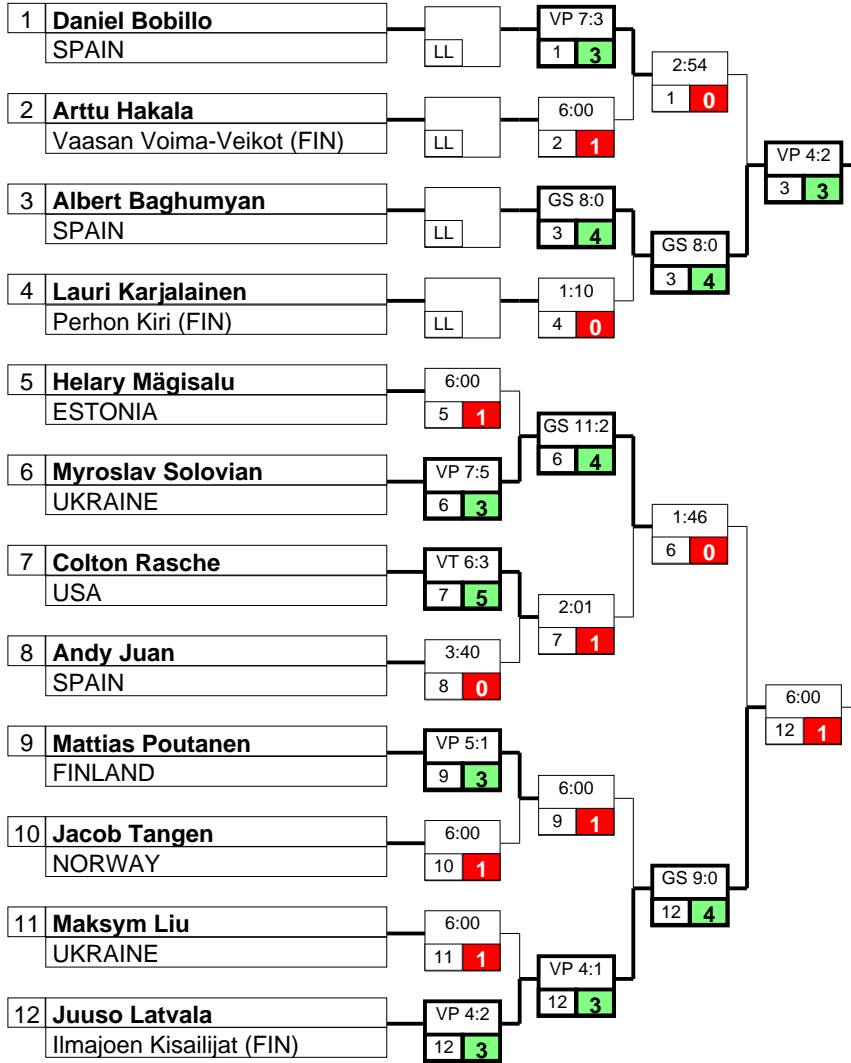

Rangliste

KPSSÜK + -

1	Albert Baghumyan (-3)				
2	Juuso Latvala (-12)				
3	Daniel Bobillo (-1)				
3	Myroslav Solovian (-6)				
5	Maksym Liu (-11)				
5	Lauri Karjalainen (-4)				
7	Colton Rasche (-7)	6	1	0	8 14
8	Mattias Poutanen (-9)	4	0	0	6 14
9	Helary Mägisalu (-5)	1	0	0	5 7
10	Arttu Hakala (-2)	1	0	0	3 7
11	Jacob Tangen (-10)	1	0	0	1 5
12	Andy Juan (-8)	0	0	0	3 6

Hoffnungsrunde der Verlierer gegen Albert Baghumyan

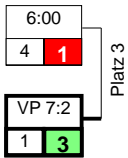

Hoffnungsrunde der Verlierer gegen Juuso Latvala

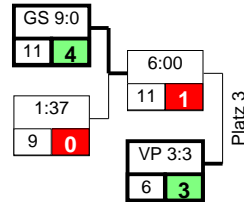



Competition Sheet

Ilmajoki, 8.12.2018

16 Participants

International Arvo Haavisto Tournament (UWW)

Senior

Category

67kg

Weight class

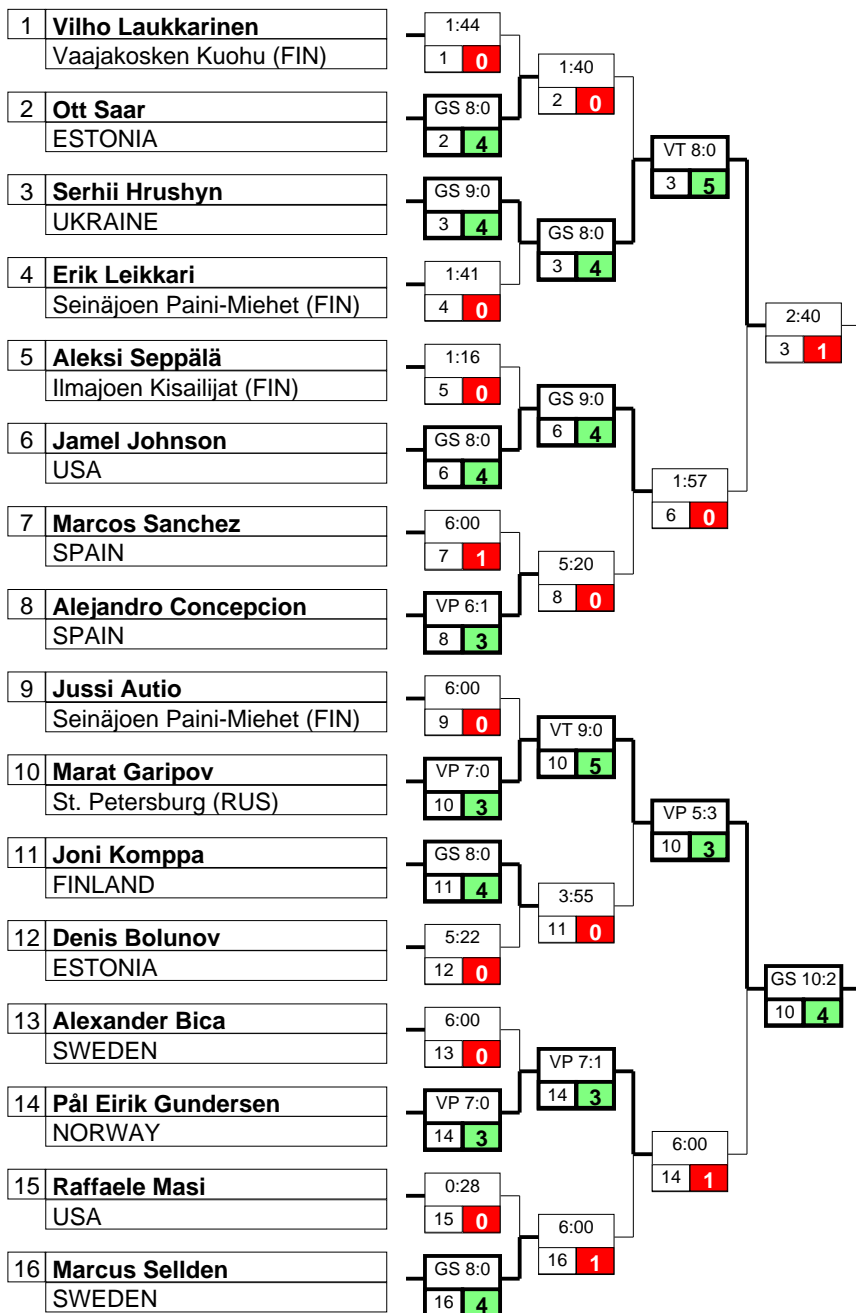

Rangliste	KPSSÜK	+	-
1	Marat Garipov (-10)		
2	Serhii Hrushyn (-3)		
3	Ott Saar (-2)		
3	Pål Eirik Gundersen (-14)		
5	Joni Komppa (-11)		
5	Jamel Johnson (-6)		
7	Marcus Sellden (-16)	5	0
8	Alejandro Concepcion (-8)	3	0
9	Erik Leikkari (-4)	1	0
10	Marcos Sanchez (-7)	1	0
11	Alexander Bica (-13)	0	0
12	Aleksi Seppälä (-5)	0	0
	Raffaele Masi (-15)	0	0
	Denis Bolunov (-12)	0	0
	Vilho Laukkari (-1)	0	0
16	Jussi Autio (-9)	0	0

Hoffnungsrunde der Verlierer gegen Serhii Hrushyn

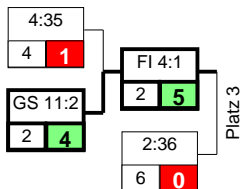

Hoffnungsrunde der Verlierer gegen Marat Garipov

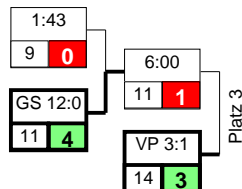



Competition Sheet

Ilmajoki, 8.12.2018

10 Participants

International Arvo Haavisto Tournament (UWW)

Senior

Category

72kg

Weight class

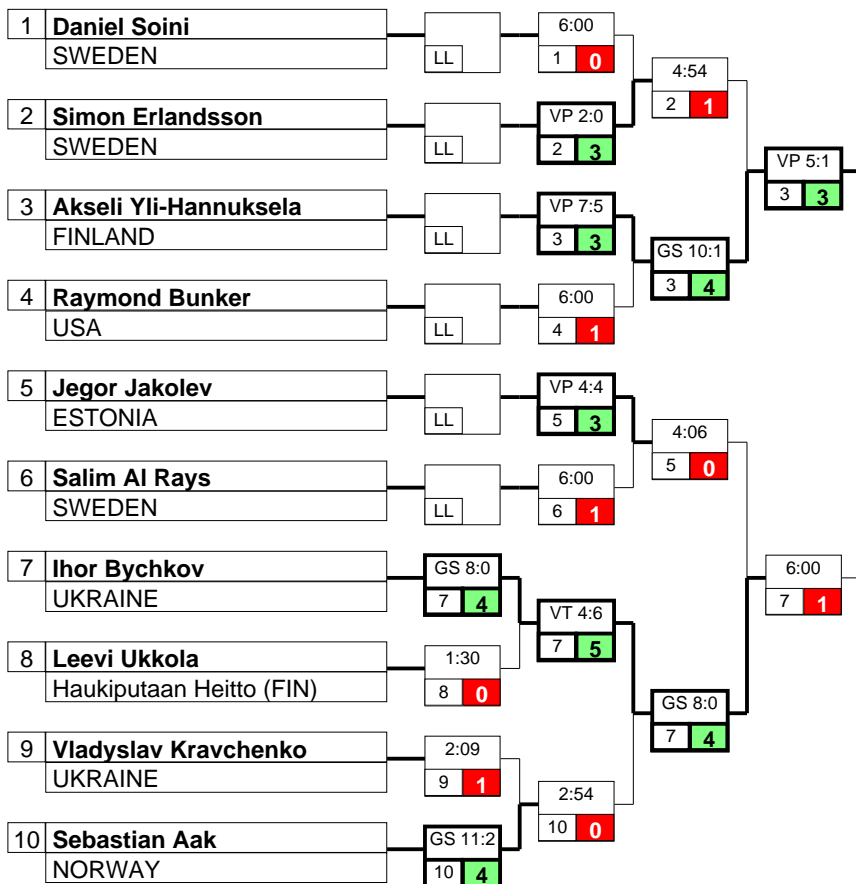

Rangliste

KPSSÜK + -

1	Akheli Yli-Hannuksela (-3)				
2	Ihor Bychkov (-7)				
3	Simon Erlandsson (-2)				
3	Sebastian Aak (-10)				
5	Jegor Jakolev (-5)				
5	Raymond Bunker (-4)				
7	Salim Al Rays (-6)	1	0	0	4 4
8	Vladyslav Kravchenko (-9)	1	0	0	2 11
9	Leevi Ukkola (-8)	1	0	0	2 21
10	Daniel Soini (-1)	0	0	0	0 2

Hoffnungsrunde der Verlierer gegen Akheli Yli-Hannuksel

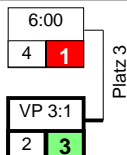

Hoffnungsrunde der Verlierer gegen Ihor Bychkov/Ihor By

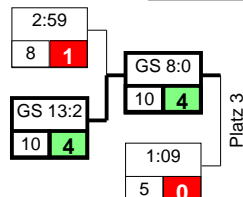



Competition Sheet

Ilmajoki, 8.12.2018

International Arvo Haavisto Tournament (UWW)

Senior

Category

77kg

Weight class

15 Participants

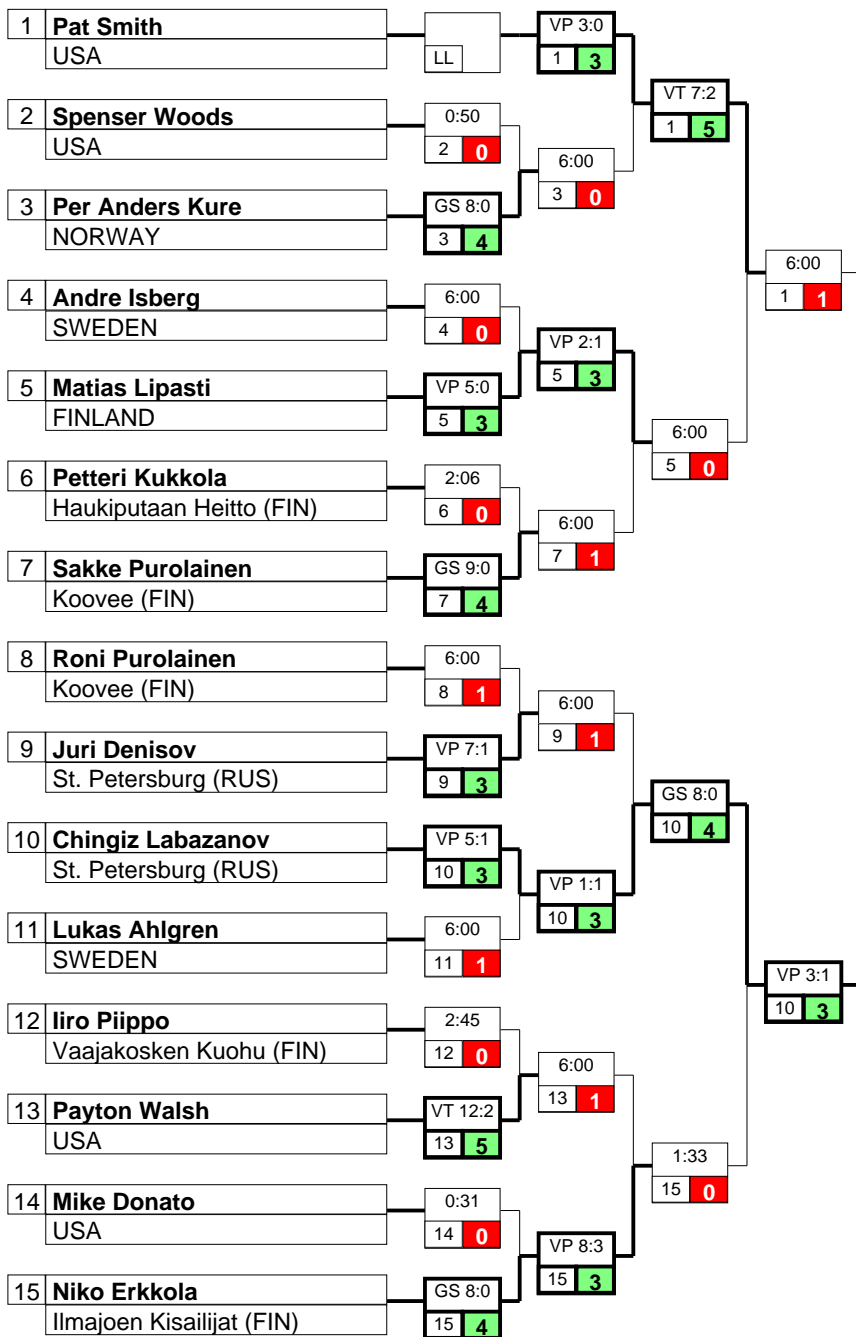

Rangliste

KPSSÜK + -

1	Chingiz Labazanov (-10)					
2	Pat Smith (-1)					
3	Niko Erkkola (-15)					
3	Per Anders Kure (-3)					
5	Juri Denisov (-9)					
5	Matias Lipasti (-5)					
7	Payton Walsh (-13)	6	1	0	15	10
8	Sakke Purolainen (-7)	5	0	0	10	2
9	Lukas Ahlgren (-11)	2	0	0	2	10
10	Roni Purolainen (-8)	1	0	0	1	7
11	Iiro Piippo (-12)	0	0	0	2	12
12	Andre Isberg (-4)	0	0	0	0	5
13	Spenser Woods (-2)	0	0	0	0	8
	Mike Donato (-14)	0	0	0	0	8
15	Petteri Kukkola (-6)	0	0	0	0	9

Hoffnungsrunde der Verlierer gegen Pat Smith

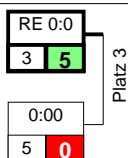

Hoffnungsrunde der Verlierer gegen Chingiz Labazanov

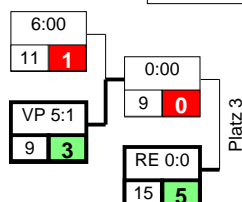



Competition Sheet

Ilmajoki, 8.12.2018

16 Participants

International Arvo Haavisto Tournament (UWW)

Senior

Category

82kg

Weight class

1	Vili Ropponen FINLAND	VP 5:1 1 3	VP 5:0 1 3	VP 5:1 1 3
2	Andreas Väilis ESTONIA	6:00 2 1		
3	Oskari Lehtonen Helsingin Haka (FIN)	VP 8:3 3 3	6:00 3 0	VP 5:1 1 3
4	Einari Ukkola Haukiputaan Heitto (FIN)	6:00 4 1		
5	Dmytro Gardubei UKRAINE	VT 4:0 5 5	VP 5:0 5 3	VP 4:0 1 3
6	Milad Gardniya Kajaanin Juntta (FIN)	1:36 6 0		
7	Oskar Johansson SWEDEN	VP 1:1 7 3	6:00 7 0	VP 5:1 1 3
8	Terrence Zaleski USA	6:00 8 1		
9	Otto Ketonen Ilmajoen Kisailijat (FIN)	FI 0:0 9 5	VP 4:0 9 3	VP 4:0 1 3
10	Hans Uku Leitham ESTONIA	0:00 10 0		
11	Raoul Aho Leitham ESTONIA	3:33 11 0	6:00 12 0	DQ 6:0 9 5
12	Exauce Mukubu NORWAY	GS 8:0 12 4		
13	Markus Sihtola Ylä-Tikkurilan Kipinä (FIN)	6:00 13 1	6:00 14 0	6:00 9 0
14	Jarno Ålander Helsingin Tarmo (FIN)	VP 4:1 14 3		
15	Vitalii Andriiovych UKRAINE	VP 12:8 15 3	VP 3:0 15 3	6:00 15 0
16	John Stefanowicz USA	6:00 16 1		

Rangliste

KPSSÜK + -

1	Vili Ropponen (-1)					
2	Otto Ketonen (-9)					
3	Vitalii Andriiovych (-15)					
3	Dmytro Gardubei (-5)					
5	Exauce Mukubu (-12)					
5	Andreas Väilis (-2)					
7	Oskari Lehtonen (-3)	4	0	0	9	10
8	Jarno Ålander (-14)	3	0	0	4	4
9	Oskar Johansson (-7)	3	0	0	1	6
10	John Stefanowicz (-16)	1	0	0	8	12
11	Einari Ukkola (-4)	1	0	0	3	8
12	Terrence Zaleski (-8)	1	0	0	1	1
13	Markus Sihtola (-13)	1	0	0	1	4
14	Hans Uku Leitham (-10)	0	0	0	0	0
15	Milad Gardniya (-6)	0	0	0	0	4
16	Raoul Aho Leitham (-11)	0	0	0	0	8

Hoffnungsrunde der Verlierer gegen Vili Ropponen

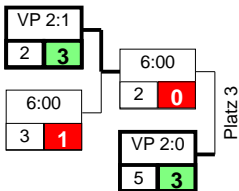

Hoffnungsrunde der Verlierer gegen Otto Ketonen

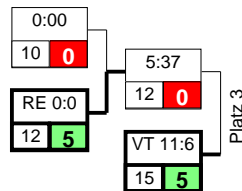



Competition Sheet

Ilmajoki, 8.12.2018

12 Participants

International Arvo Haavisto Tournament (UWW)

Senior

Category

87kg

Weight class

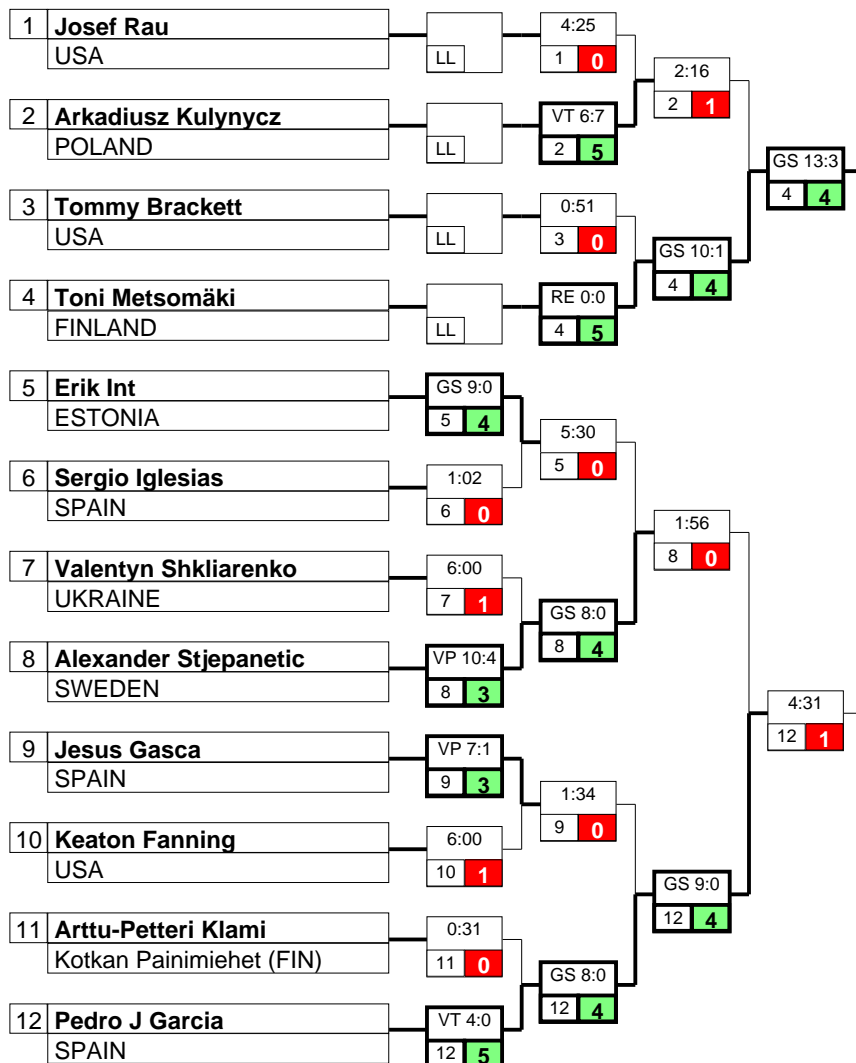

Rangliste	KPSSÜK	+	-
1 Toni Metsomäki (-4)			
2 Pedro J Garcia (-12)			
3 Alexander Stjepanetic (-8)			
3 Arkadiusz Kulynycz (-2)			
5 Jesus Gasca (-9)			
5 Tommy Brackett (-3)			
7 Erik Int (-5)	4	0	0
8 Valentyn Shkliarenko (-7)	1	0	0
9 Keaton Fanning (-10)	1	0	0
10 Josef Rau (-1)	0	0	0
11 Sergio Iglesias (-6)	0	0	0
12 Arttu-Petteri Klami (-11)	0	0	0

Hoffnungsrunde der Verlierer gegen Toni Metsomäki

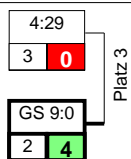

Hoffnungsrunde der Verlierer gegen Pedro J Garcia

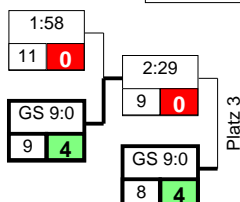



Competition Sheet

Ilmajoki, 8.12.2018

International Arvo Haavisto Tournament (UWW)

Senior

Category

97kg

Weight class

9 Participants

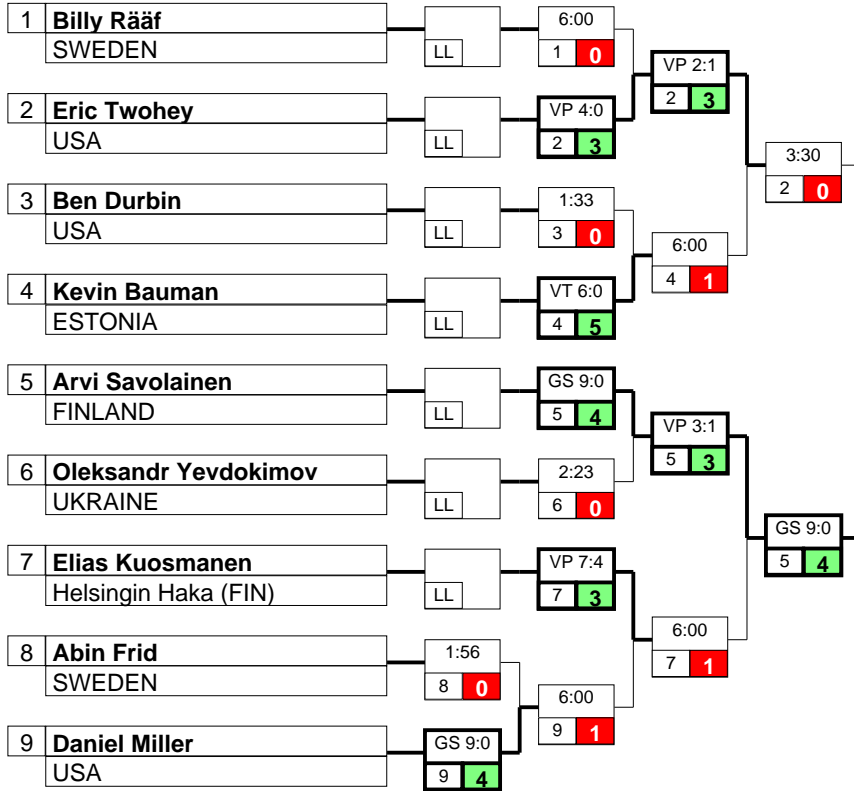

Rangliste

KPSSÜK + -

1	Arvi Savolainen (-5)								
2	Eric Twohey (-2)								
3	Billy Rääf (-1)								
3	Elias Kuosmanen (-7)								
5	Oleksandr Yevdokimov (-6)								
5	Kevin Bauman (-4)								
7	Daniel Miller (-9)	5	0	0	13	7			
8	Ben Durbin (-3)	0	0	0	0	6			
9	Abin Frid (-8)	0	0	0	0	9			

Hoffnungsrunde der Verlierer gegen Eric Twohey

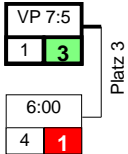

Hoffnungsrunde der Verlierer gegen Arvi Savolainen

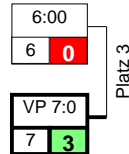



Competition Sheet

Ilmajoki, 8.12.2018

International Arvo Haavisto Tournament (UWW)

Senior

130kg

8 Participants

Category

Weight class

1	Georgi Helaya St. Petersburg (RUS)
2	Nicolas Lopez Gredilla SPAIN
3	Konsta Mäenpää FINLAND
4	Artur Vititin ESTONIA
5	Kaarel Maaten ESTONIA
6	Tuomas Lahti Ylä-Tikkurilan Kipinä (FIN)
7	Nikola Milatovic NORWAY
8	Trent Osnes USA

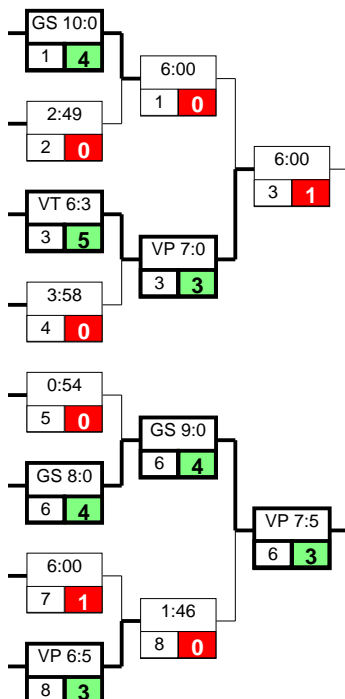

Rangliste

KPSSÜK + -

1	Tuomas Lahti (-6)				
2	Konsta Mäenpää (-3)				
3	Kaarel Maaten (-5)				
3	Artur Vititin (-4)				
5	Georgi Helaya (-1)				
5	Trent Osnes (-8)				
7	Nikola Milatovic (-7)	1	0	0	5
8	Nicolas Lopez Gredilla (-2)	0	0	0	10

Hoffnungsrunde der Verlierer gegen Konsta Mäenpää

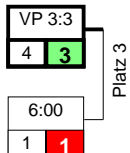

Hoffnungsrunde der Verlierer gegen Tuomas Lahti

